

Data Sheet



Article number: 20251412

Description: E+G Clamping pad
GN 709.1-20-M8-B

Measures

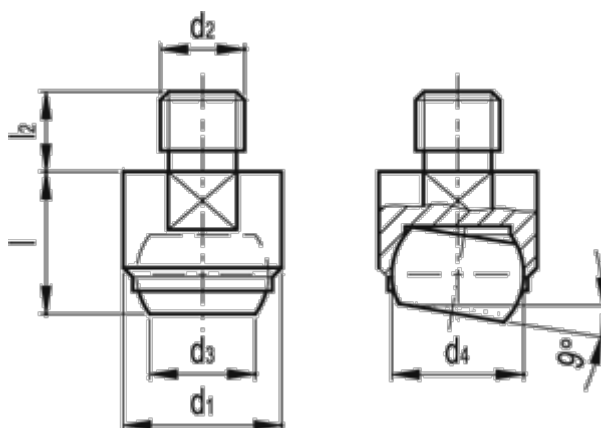

d1	= 20
d2	= M8
d3	= 10.5
d4	= 16
l +/-0.02	= 18
l2	= 10
Max static load (KN)	= 25
s	= 17

Weight (g) = 38